



BASEMENT WINDOW SYSTEMS

Bracing Section

To download instructions for later viewing, go to the File Menu, then Save As... and save to desired location.

Welcome to the Bracing Section

When bracing a Boman Kemp 4040 window buck, cut a 2X4 to 48 1/2" and place in the center of window buck.



Nail through center of head into wood brace on both the top and bottom of buck for delivery to job site.



You are now ready to move on to the appropriate Install Section.



Interior Wall Finish

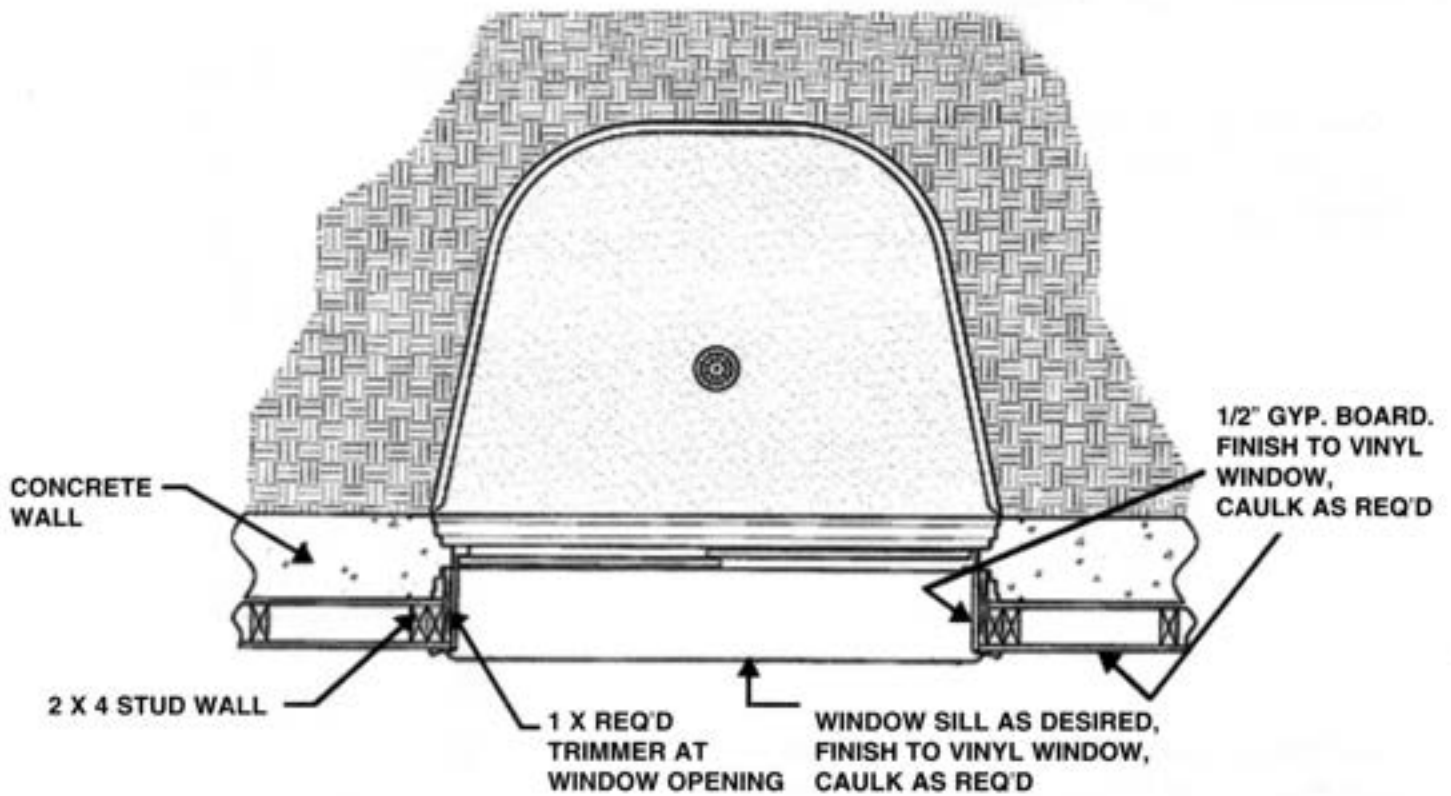

SUGGESTED INTERIOR FINISH DETAILS



BASEMENT WINDOW SYSTEMS

Window Install Section

To download instructions for later viewing, go to the File Menu, then Save As... and save to desired location.

Welcome to the Window Install Section

Make sure window buck is clear of all debris. Clean sill with a putty knife.



Install window from the outside. Install window over sill using fins located on bottom of window frame.



• **Important:** Make sure window is pulled securely into place. Apply downward pressure to ensure window sill is set securely into place. Installation made easier by removing the slider and screen.

Hold frame of window in place while lining up trim piece for install. Make sure trim piece is aligned correctly for install.

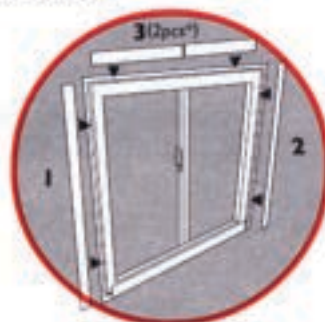

• Less than 4'- 0" 1 pc.

Window is locked into place by three vinyl trim pieces. The sill (bottom) trim is pre-installed at the window factory.

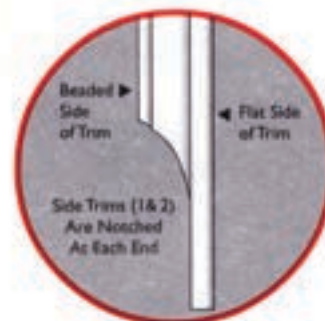

Install the side trim pieces (1 & 2) first. Position the trim on the window and tap the trim with a rubber mallet working from bottom towards the top.

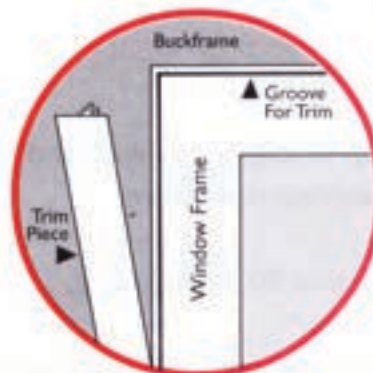
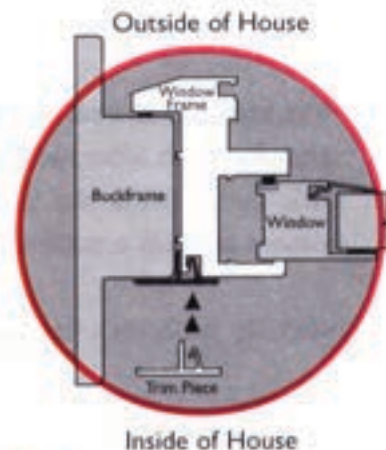

• **Important:** Be sure to begin tapping the trim with the rubber mallet from the bottom and working toward the top.

Repeat above steps for other trim (side).

Repeat above step for the head (top) (3) working trim from one side to the other.



You have now completed the Window Installation.

Basement Egress Windows Made Easy!

www.boman-kemp.com



BASEMENT WINDOW SYSTEMS

EasyBuck™ Assembly

To download instructions for later viewing, go to the File Menu, then Save As... and save to desired location.

Welcome to the EasyBuck™ Assembly Section

First, separate the sill and jamb parts. Jamb is the same for both sides, with female slots and attached buck nuts. Sill is the same on both the top and bottom and has a male tab.

Next, lay jamb on a flat surface.

Tilt sill at a 45 degree angle and insert end tab into jamb slot using downward pressure.

Return sill to a vertical 90 degree angle.

Repeat process on opposite end of jamb using remaining sill.

Before installing remaining jamb, make sure that corners of the jamb are tucked slightly to allow for overlap from sill.

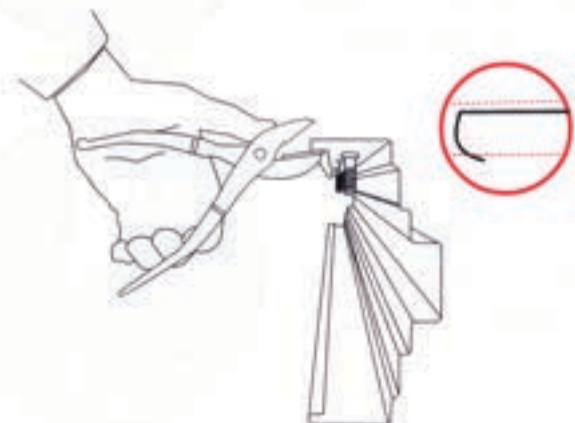
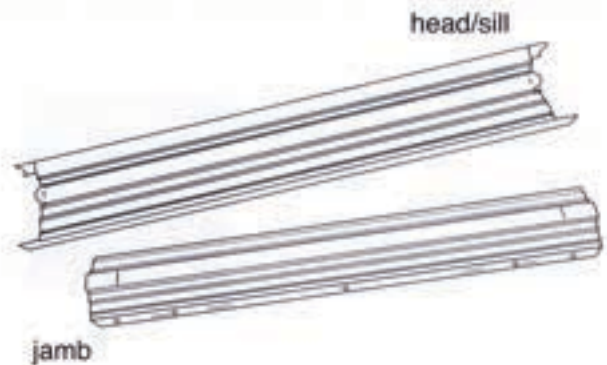

Making sure that buck nuts on both jambs are on the same side, apply downward pressure on jamb. Use the end of a mallet to align sill tab with jamb slot.

Once aligned, insert sill tab into jamb slot making sure sill tab remains upright.

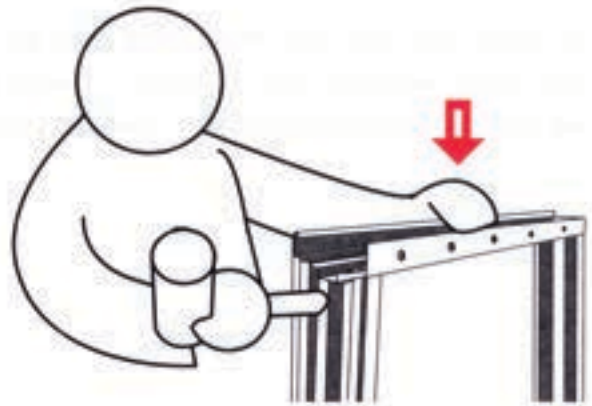

Use end of a mallet to straighten tab back to a vertical alignment of 90 degrees.

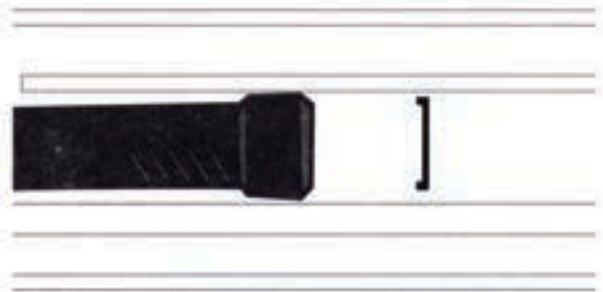

Place a small block of 2X4 wood in jamb channel. Butt against the male tab which has been pushed through and hammer.

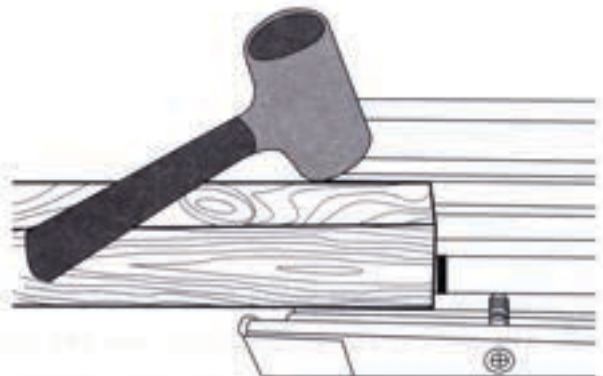

Be sure to look for the tooth on the male tab, which will kick out and lock in place leaving tab vertical. Then bend tab down toward the inside.

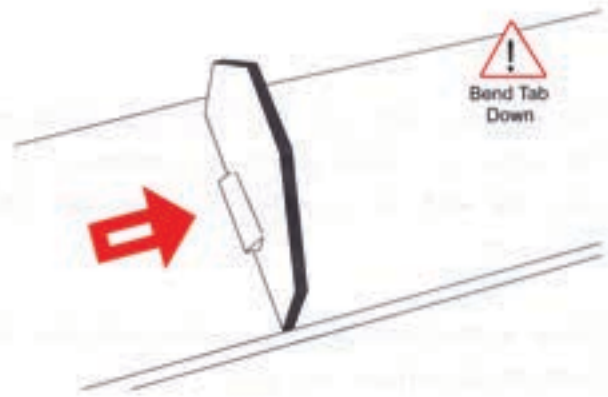

Tap outer edge of sill into place with mallet, making sure that sill corner wrap is overlapping jamb wrap, and jamb wrap is channeled in sill alignment notch.



Be sure that you have proper overlap and alignment of sill and jamb.

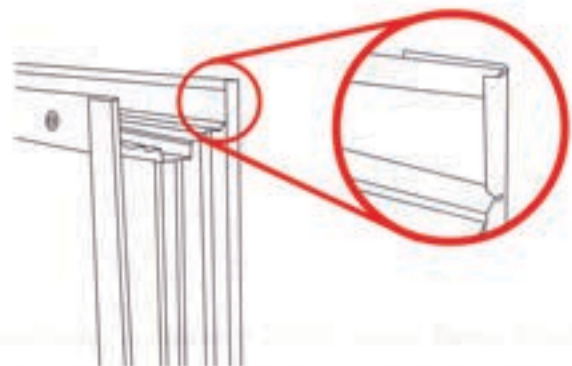

Repeat the previous steps on the opposite end of sill. Lift and rotate entire frame and repeat these steps again making sure all four corners are properly seated.

Now you have completed the EasyBuck™ Assembly and are ready to go on to the bracing section.





BASEMENT WINDOW SYSTEMS Safety Section

To download instructions for later viewing, go to the File Menu, then Save As... and save to desired location.

Welcome to the Safety Section

To meet IRC 2000 Egress Code, attach ladder to well with sheet metal screws using pre-drilled holes on ladder.

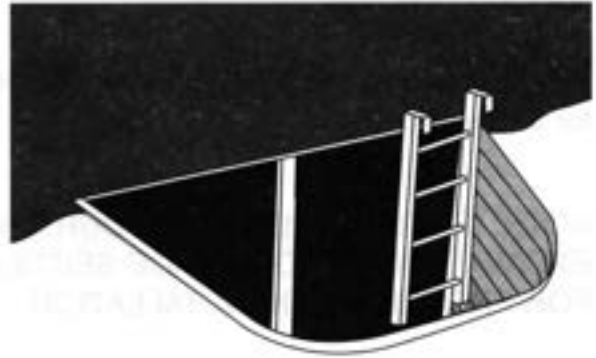

Prevent accidental fall-ins with Boman Kemp safety grates and clear lexan covers. Safety grates and covers prevent children, animals, debris, and water from entering area well.

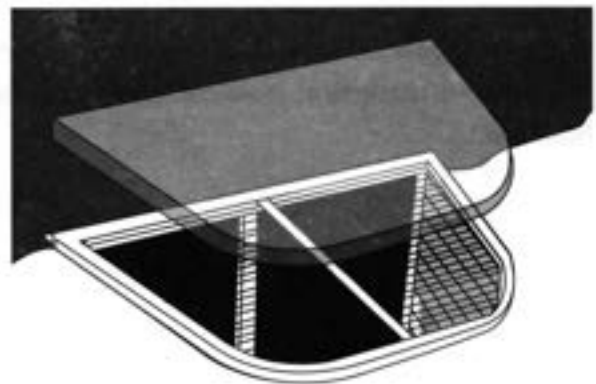



BASEMENT WINDOW SYSTEMS

Well Install-Wall Mount

To download instructions for later viewing, go to the File Menu, then Save As... and save to desired location.

Welcome to the Well Install Wall Mount Section

Mount well on wall allowing 12" below the window
for proper drainage.

NOTE: IF DRAIN IS EXPOSED DURING
EXCAVATION, SEE DRAINAGE SECTION
FOR PROPER DRAIN INSTALLATION.

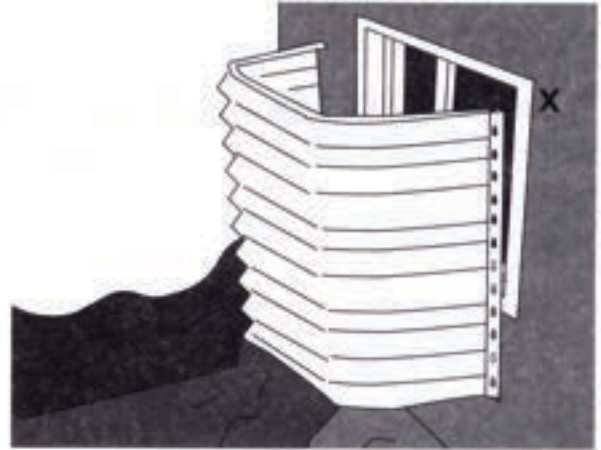

Once window is installed verify measurement
of well, and mark first hole for mounting and drill
hole out.

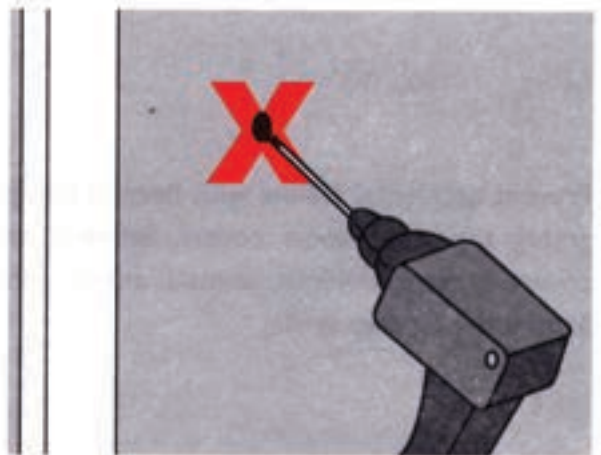

Insert an expansion bolt in the hole using a hammer.



Line up the top mounting hole with the expansion bolt, and hang well on wall. While still holding the well, making sure that the expansion bolt has slid securely into place, use a level to mark the placement of the other bolts on the wall.

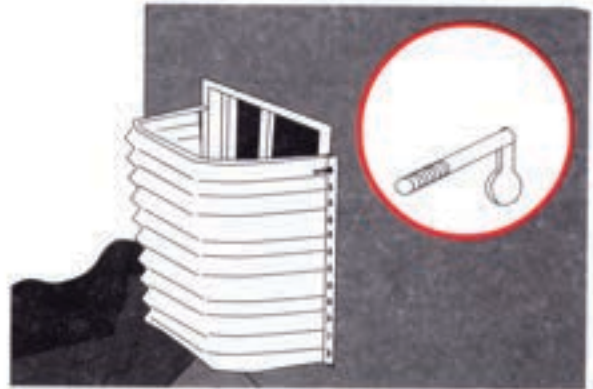

Be sure to mark the X for drilling at the top of the mounting eyelet, so that the well remains level. Remove the well after holes have been marked. Drill the X's for the mounting holes just as the first one was done. When finished, insert expansion bolts in each hole drilled and mount well using a washer and a nut.

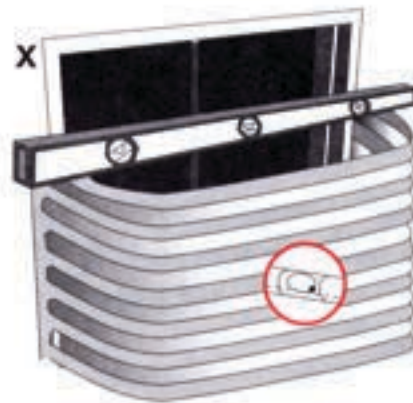

For proper mounting use the top two holes on the well and then every 10" down the well. Make sure that the bottom hole has a screw so that all four corners are securely fastened during backfill.

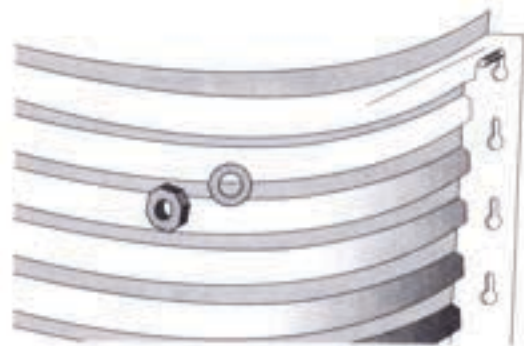

! ALERT: WATERPROOF AND ADDRESS DRAINAGE PRIOR TO BACKFILL.

You have now completed the Wall Mount Well Install.

! ALERT: PREVENT ACCIDENTAL FALL-INS. SEE SAFETY SECTION FOR LADDERS, SAFETY GRATES AND CLEAR LEXAN COVERS.

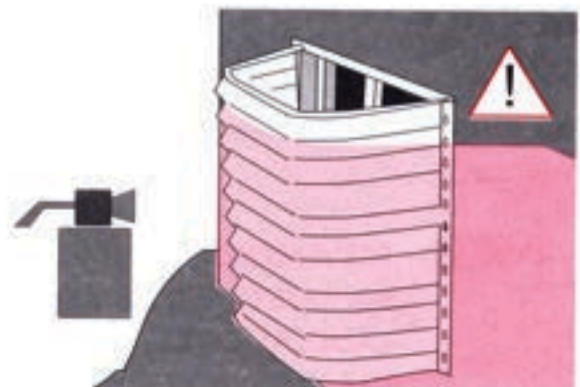



BASEMENT WINDOW SYSTEMS

Well Install Buck Mount Section

To download instructions for later viewing, go to the File Menu, then Save As... and save to desired location.

Welcome to the Well Install Buck Mount Section

Proper side view of how the well can be installed is shown.

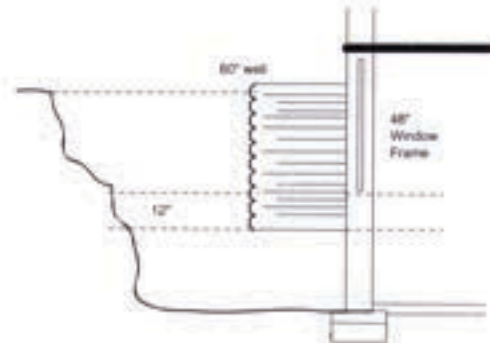

For EasyWell™ buck mount install, simply back out each buck nut on the frame.

Hang well on extended buck nuts, making sure top hole on well is secured on both sides with a buck nut or expansion bolt if well sits higher than the buck frame.

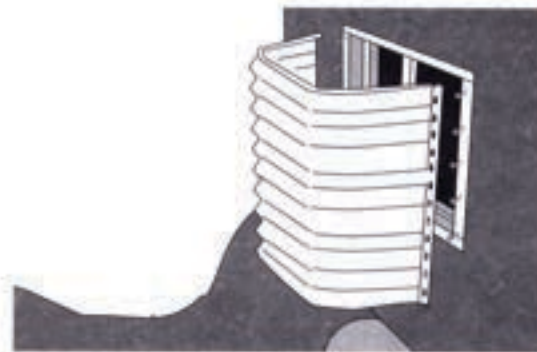

NOTE WHERE BUCK SCREWS LINE UP.

Once the EasyWell™ has been set on the buck screws, simply tighten screws to EasyWell™ making sure there are screws in the top two holes of the EasyWell™ and then every 10" down the well. Make sure that the bottom hole has a screw so that all four corners are securely fastened during backfill.

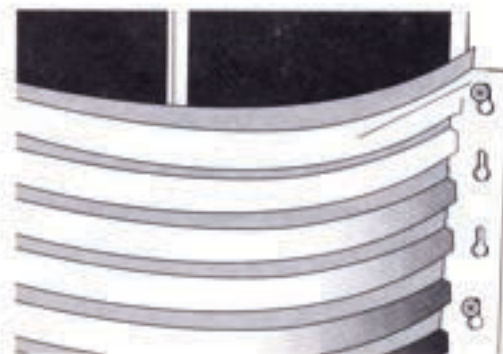

! ALERT: WATERPROOF AND ADDRESS DRAINAGE PRIOR TO BACKFILL.

You have now completed the Buck Mount Well Install.

! ALERT: PREVENT ACCIDENTAL FALL-INS. SEE SAFETY SECTION FOR LADDERS, SAFETY GRATES AND CLEAR LEXAN COVERS.

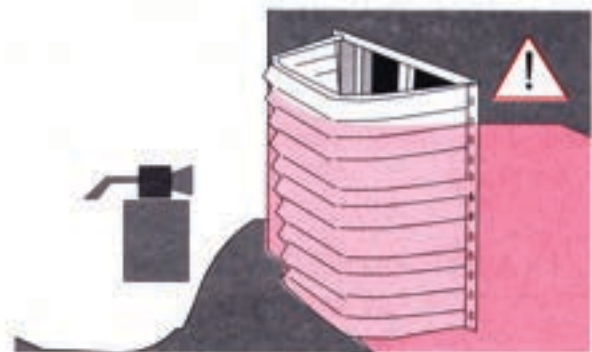



BASEMENT WINDOW SYSTEMS

Drainage / Backfill Section

To download instructions for later viewing go to the File Menu, then Save As... and save to desired location.

Welcome to the Drainage / Backfill Section

Before starting, note that not all states are required by code to install footing drains. This may not apply to all applications. Here is a proper side view of a drain, but this is simply one way to do a drain install.

During foundation drain tile install, simply splice pipe under window well location and install a T-joint underneath it.

Once T-joint is installed, in-lay a drain piece that will end up sitting 4" to 6" below the sill of the window.

Use a 2X4 and a piece of wire to secure the drain pipe for back filling. Once secure, proceed with back fill until it is 4" to 6" below the sill.

Back fill with a 1" stone or less, depending on soil density in your area. Check with local municipality for soil charts.

Drain should sit in the center of the well and should be kept clear of debris.

You are now ready to move on to the Window Install Section.

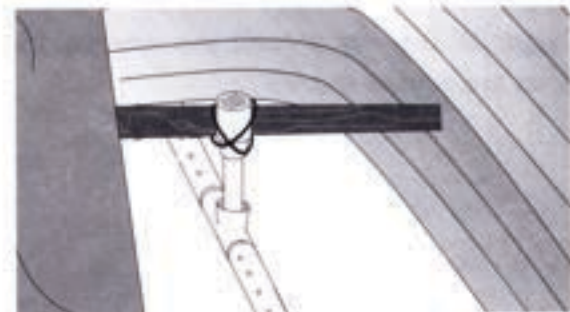
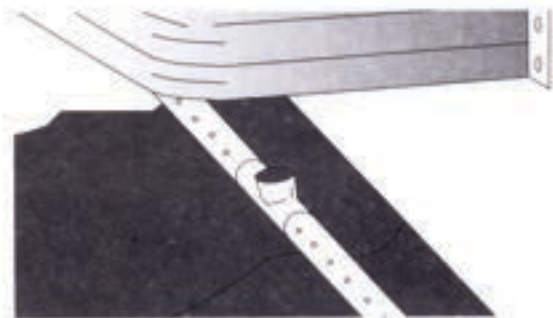
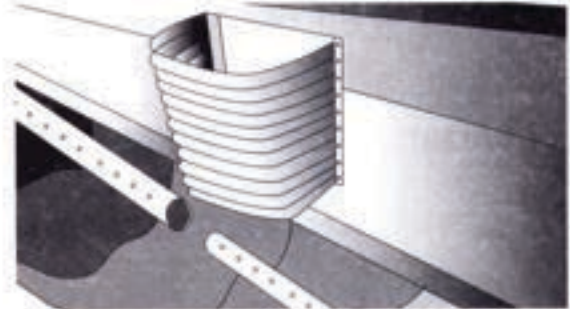



BASEMENT WINDOW SYSTEMS

Retro-Fit Section

Welcome to the Retro Fit Install Section

! ALERT: BEFORE STARTING A WINDOW RETRO FIT, CONTACT LOCAL MUNICIPALITY FOR PERMITS.

Excavate area for window installation. Remove dirt all the way to foundation's footings, making well install easier.

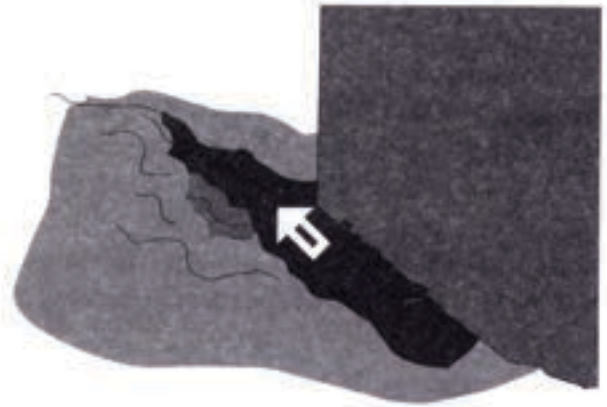

Whether using a contractor or cutting the hole yourself, outline a square on the wall that is $3\frac{1}{2}$ " bigger all the way around the window. Make sure lines are square and 90° .

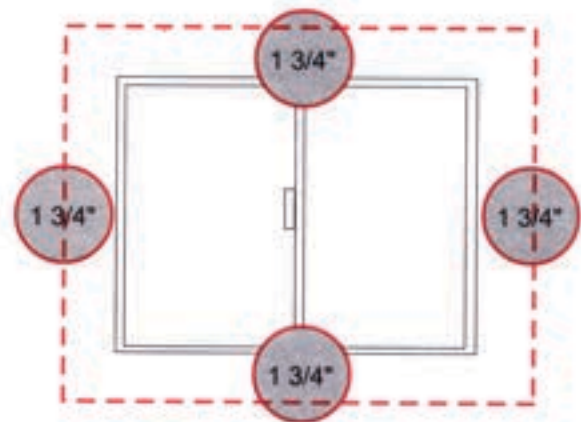

Cut and remove the piece out of the wall.

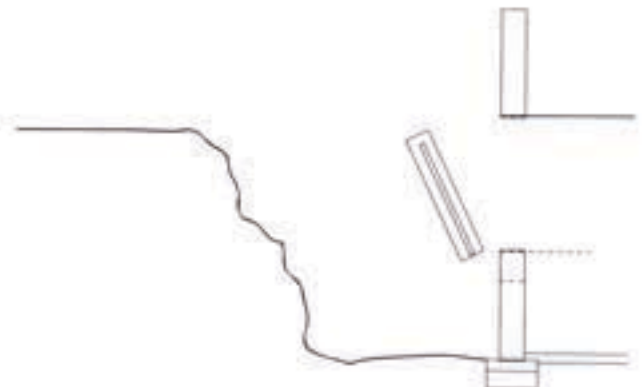

Using womanized lumber, build a frame for the window to sit in. Secure the wood using silicone. Once silicone is dry use concrete fasteners to secure lumber properly.

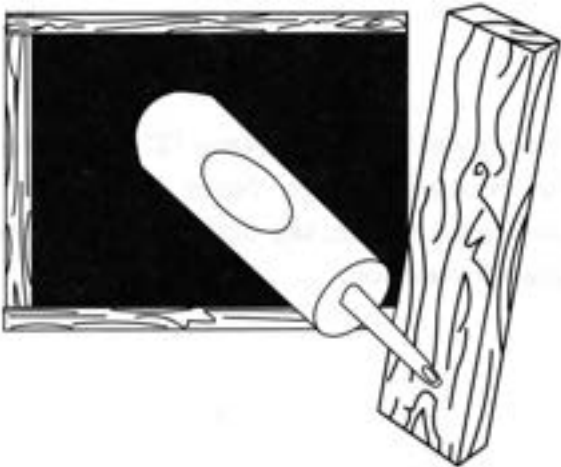

Anchor locations. Fasten into concrete opening with concrete fasteners.

Place window in lumber frame preparing each inside edge first with silicone.

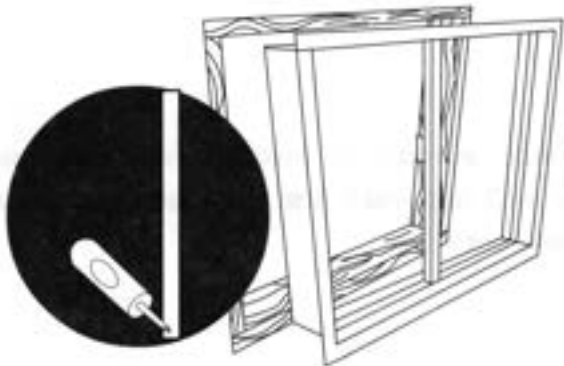

Using 1½" galvanized screws, continue securing windows in wood frame using the holes provided on window frame.



Mount well on wall allowing 12" below the window for proper drainage. Note: If drain is exposed during excavation, see drainage section for proper drain installation.



Once window is installed verify measurement of well, and mark first hole for mounting and drill hole out.

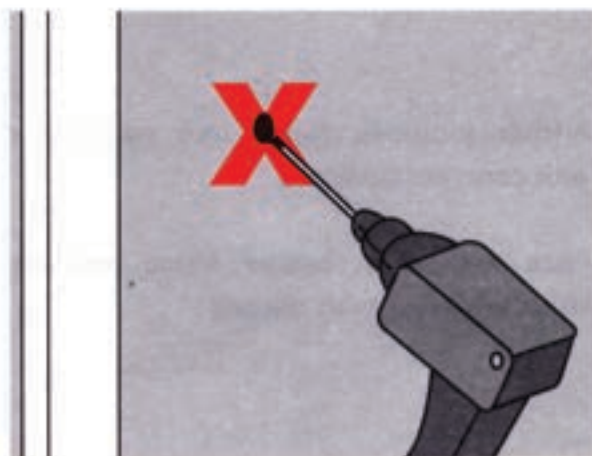

Insert an expansion bolt in the hole using a hammer.



Line up the top mounting hole with the expansion bolt, and hang well on wall. While still holding the well, making sure that the expansion bolt has slid securely into place, use a level to mark the placement of the other bolts on the wall.

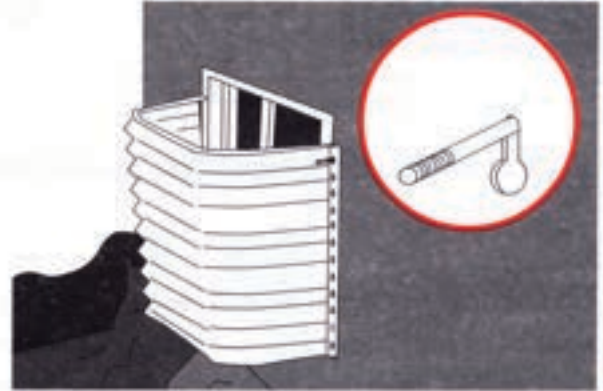

Be sure to mark the X for drilling at the top of the mounting eyelet, so that the well remains level. Remove the well after holes have been marked. Drill the X's for the mounting holes just as the first one was done. When finished, insert expansion bolts in each hole drilled and mount well using a washer and a nut.

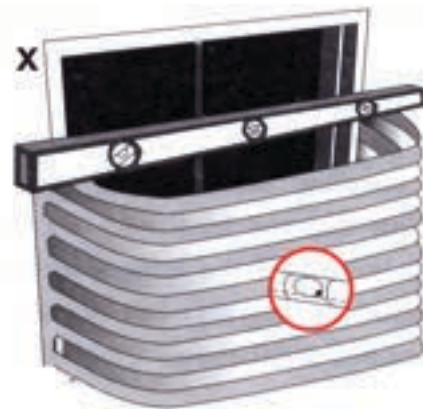

For proper mounting use the top two holes on the well and then every 10" down the well. Make sure that the bottom hole has a screw so that all four corners are securely fastened during backfill.

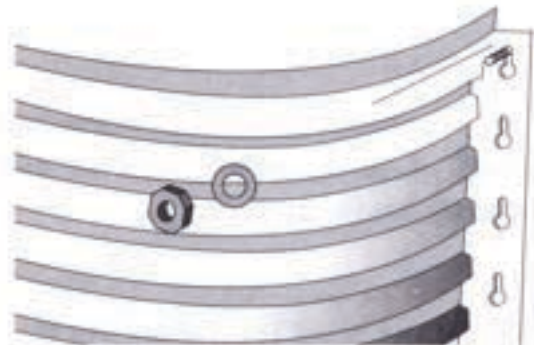

 **ALERT: WATERPROOF AND ADDRESS DRAINAGE PRIOR TO BACKFILL.**

You have now completed the Wall Mount Well Install.

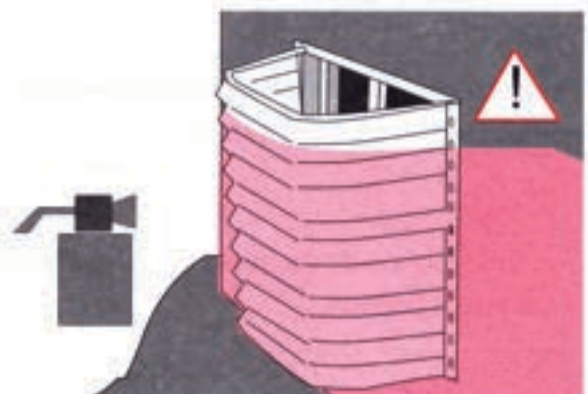



BASEMENT WINDOW SYSTEMS

Block Wall Section

To download instructions for later viewing, go to the File Menu, then Save As... and save to desired location.

Welcome to the Block Wall Install Section

Locate area for window installation. Apply a heavy coat of mortar along top surface where frame is to be installed. Place braced EasyBuck over mortar.

 **ALERT: BUCK SHOULD BE BRACED WITH 2X4 BEFORE INSTALLATION.**

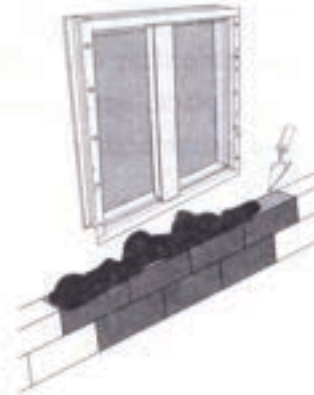

When installing window buck into block wall, make sure that the buck nuts are facing out and that the bottom of the buck is no more than 40" from floor for Egress. See Egress Section for complete IRC 2000 code.



As wall continues upward, fill mortar down side channels of jambs, making sure all cavities are completely filled with mortar.

NOTE: MAKE SURE THAT MORTAR IS COMPACTED TIGHTLY AROUND BUCK NUTS.

Finish by completely filling top header with mortar and placing block over frame.

You are now ready to move on to the Wall Mount Well Install Section.





BASEMENT WINDOW SYSTEMS

Aluminum Form Section

To download instructions for later viewing, go to the File Menu, then Save As... and save to desired location.

Welcome to the Aluminum Form Install Section

Once aluminum forms are in place, locate where window is to be placed. Insert braced EasyBuck™.



ALERT: BUCK SHOULD BE BRACED WITH 2X4 BEFORE INSTALLATION

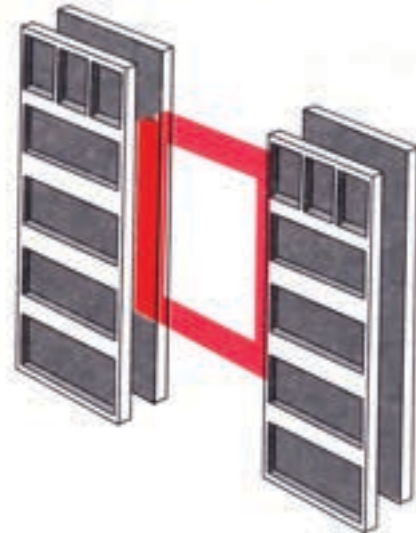

While inserting window buck into wall, make sure that the buck nuts are facing out and that the bottom of the buck is no more than 40" from floor for Egress. See Egress Section for complete IRC 2000 code.

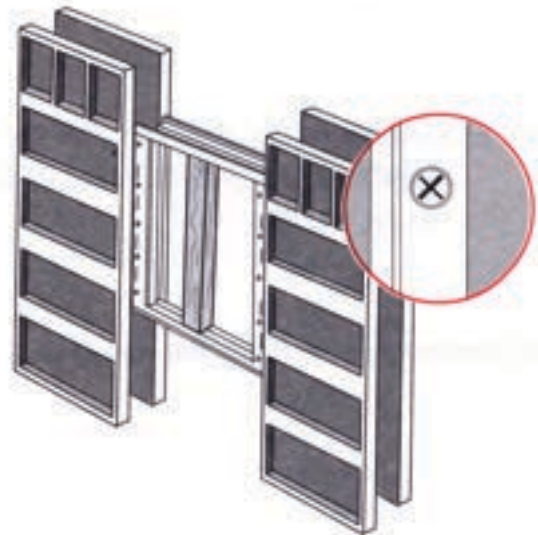

Once tie slots are found on buck, insert tie thru aluminum form and thru buck tie slot to other side of form.

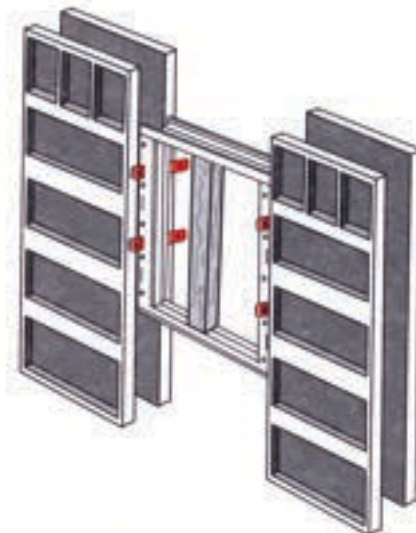

Pin and secure tie.

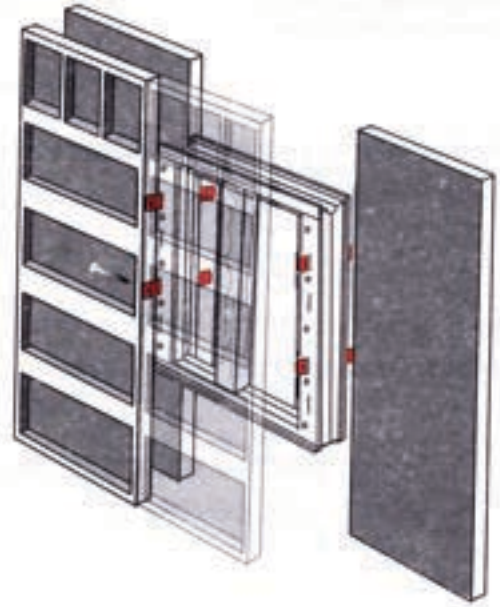

NOTE: STANDARD BOMAN KEMP 4040 WINDOW REQUIRES A 36" AND 18" FILLER PANEL.

The window is now ready for wall pour.

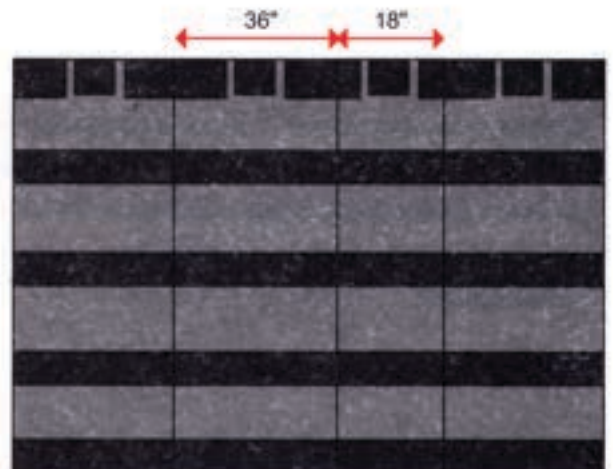



BASEMENT WINDOW SYSTEMS

Wood Form Section

To download instructions for later viewing, go to the File Menu, then Save As... and save to desired location.

Welcome to the Wood Form Install Section

Once one side of wood form is installed, locate area for window.



ALERT: BUCK SHOULD BE BRACED WITH 2X4 BEFORE INSTALLATION.

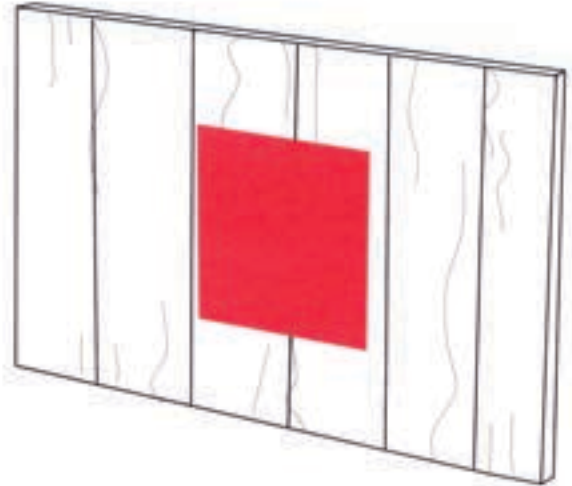

With buck screws facing out, attach one corner of buck to wood form making sure the bottom of the buck is no more than 40" from the floor for Egress. See Egress Section for complete IRC 2000 code.

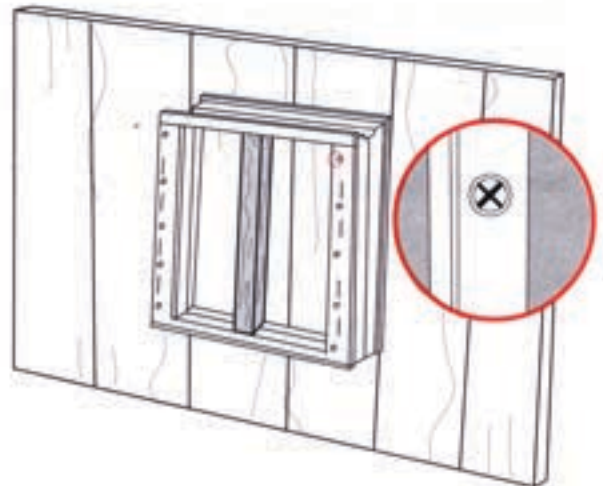

With one corner attached to the wood form, use that area to pivot the Easybuck™ frame until it is level.

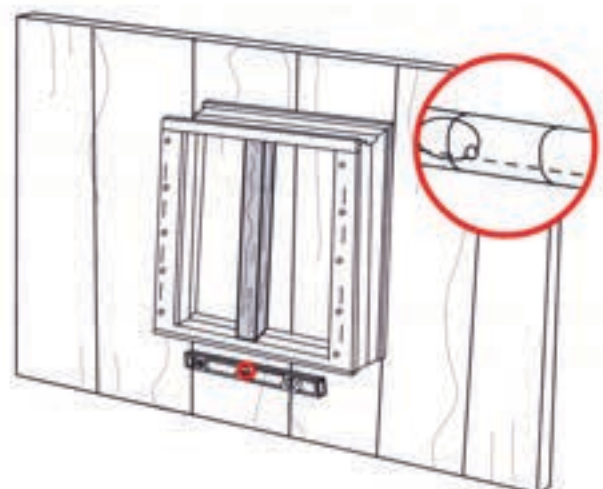

Pound 1st nail on top of buck.

Check level again before setting 2nd nail on top.



Once you are level, drive remaining nails – three on each side. Upon attachment, make one final check for squareness by cross measuring the frame.

Next, nail inside.

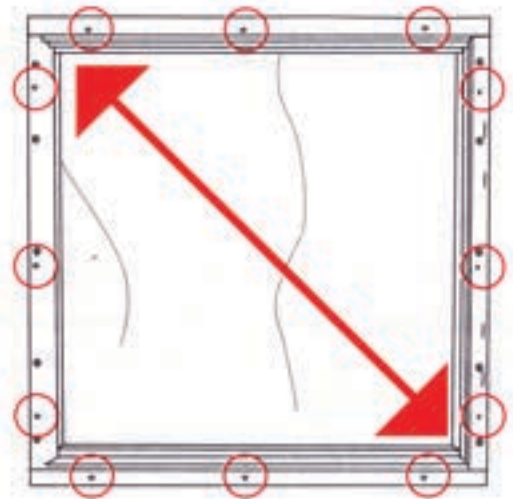

Once the second wood form is in place, locate buck in wall and nail thru from outside of wood form.

EasyBucks™ are able to withstand normal installation functions such as pouring, pumping, and vibrating.

You are now ready to move onto the Well Install Section.

